

INSTRUCTION MANUAL
 ELECTRIC PARASOL HEATER
 MODEL: 60404

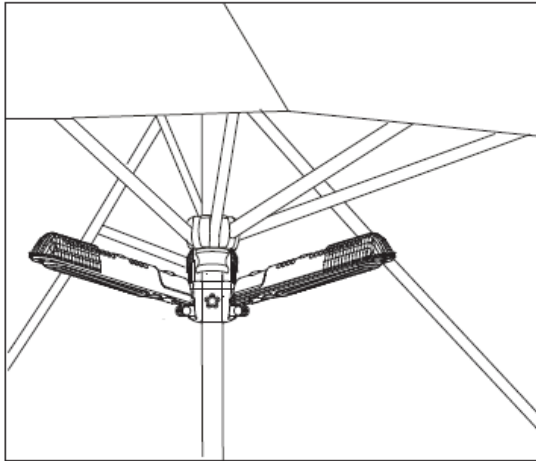

PARTS

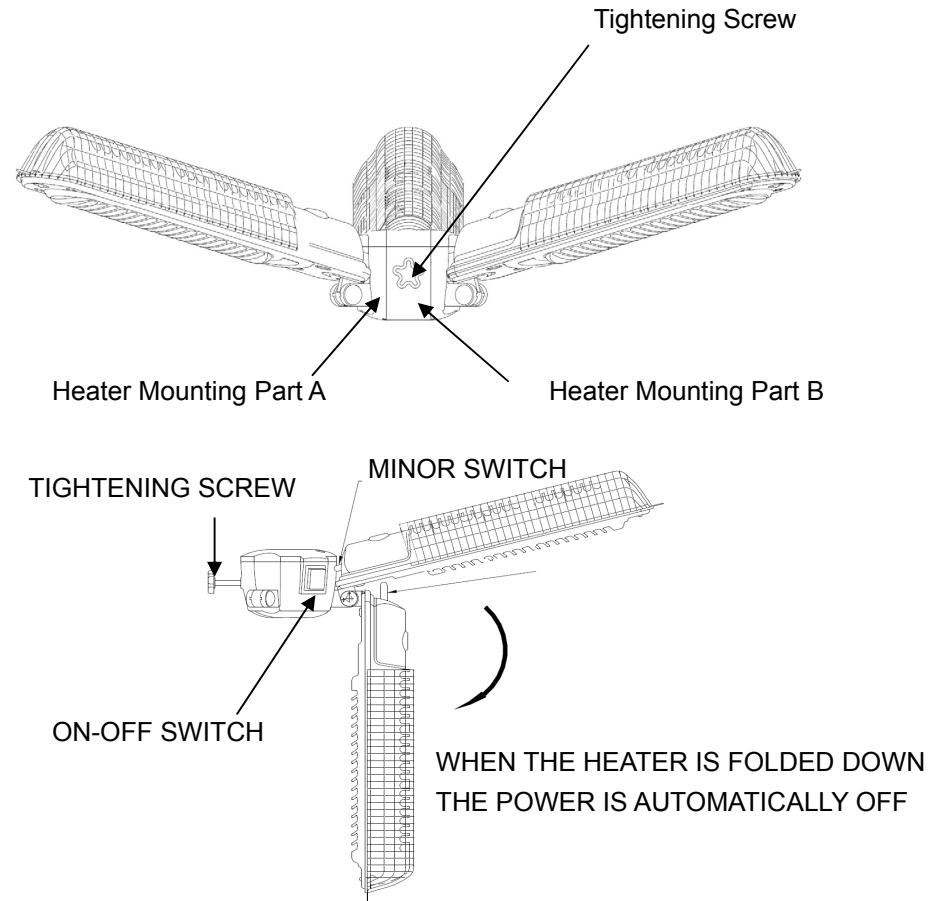

1. Make sure that all the parts are present and that there are no missing parts, Please empty the carton thoroughly to make sure after unpacking the unit from the box
2. Do not PLUG THE UNIT IN UNTIL THE UNIT IS COMPLETELY ASSEMBLED ON THE UMBRELLA AND THERE IS NO DAMAGE to the unit and power cord.

**IF THERE IS ANY DAMAGE OR MISSING PARTS, PLEASE CONTACT
 WELL TRAVELED LIVING AT 866-985-7877 OR EMAIL cservice@welltraveled.net.
 (SEE WARRANTY SECTION)**

ASSEMBLY

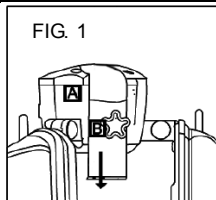

FIG. 1

MAKE SURE THE HEATER PANELS ARE FOLDED DOWN BEFORE MOUNTING THE HEATER ON THE UMBRELLA.

1. Remove the heater brace from the heater body by sliding it downward. (Fig. 1)
2. Place the heater onto an umbrella pole between 1 inch (25mm) – 2 inches (48mm) in diameter by inserting the pole into the slot. (Fig. 2)

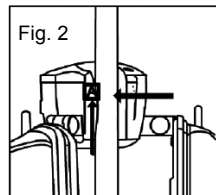

Fig. 2

3. Place the heater brace back on by sliding it upward. (Fig. 3)
4. Secure the heater to the umbrella pole by turning the tightening screw clockwise until the heater is secure on the umbrella pole.

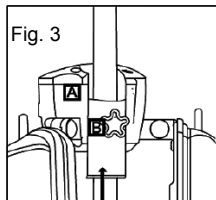
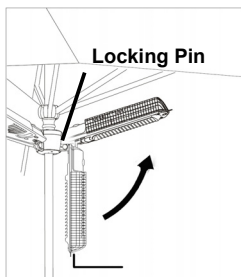

Fig. 3

5. Using the wire loop at the end of the heater panel, pull the heater panel up until a click is heard. This means that the panel is now locked into position.

NOTE : DO NOT FOLD THE PANELS DOWN WITHOUT FIRST PUSHING THE LOCKING PIN IN.



Locking Pin

6. To fold any of the panels down, press the metal locking pin at the hinge of the heater panel, then holding onto the wire loop at the front end of the heater, fold the heater panel down.

NOTE: WAIT UNTIL THE HEATER PANELS HAVE ALL COOLED DOWN BEFORE FOLDING THE HEATER PANELS DOWN.

7. When any of the heater panels are folded down while the unit is on, that panel will shut-off, because on the back of the panel is a shut-off switch so that only two or even one heater panel can be used instead of all three panels.

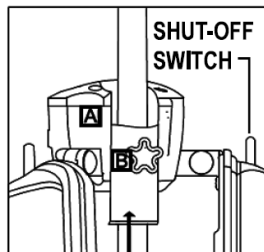

OPERATION INSTRUCTIONS

1000W OF HEAT

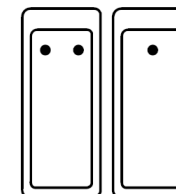

500W OF HEAT

1. Connect the plug to a 120V/60Hz outlet.
2. Press the Toggle switch on the unit with the "•" for 500W of heat. Only one heater panel will activate. Press the "• •" toggle switch only and two heater panels will activate producing 1000W of heat. Press the two toggle switches together to produce 1500W of heat.
3. To turn off the heater, press both toggle switches downward.

REMEMBER, portable electric heaters are designed for spot heating or as a supplementary heat source. They are not intended to be the main source of heat during the cold months.

Overheat protection shut-off

If an overheat temperature is reached, the heater will automatically shut off. It can only resume operation when the user resets the unit. Inspect and remove any objects on or adjacent to the heater that may cause high temperature.

To reset the heater:

1. Turn the heater off.
2. Unplug the heater.
3. After 5-10 minutes, plug the unit in again and operate normally.

Caution: You must always take care that there is sufficient distance for safety (at least 3 ft/50cm) between the apparatus and the wall or other objects or combustible materials.

Avoid the use of an extension cord. However, if you must use an extension cord, the cord should be NO.14 AWG minimum size and rated not less than 1875 W

FOR YOUR SAFETY

IMPORTANT INSTRUCTIONS

ONLY USE THE UNIT ON A SECURED VERTICAL POLE THAT IS FIRMLY IN PLACE.

1. READ ALL INSTRUCTIONS BEFORE OPERATING THIS HEATER.
2. This heater is not intended for use in bathrooms, laundry areas or similar indoor locations where there may be moisture. Never place heater where it may fall into a bathtub, swimming pool, or other water receptacle.

3. This unit is intended for household use only. DO NOT use the unit in such areas as construction sites, greenhouses, barns or stables or any place that has flammable materials.
4. DO NOT use the unit without a supporting pole.
5. A heater has hot, arcing or sparking parts inside. Do not use it in areas where gasoline, paint or flammable liquids are used or stored.
6. DO NOT move the unit when still connected to an electrical outlet.
7. Always wait for the unit to cool down before moving, cleaning and storing.
8. DO NOT touch the front of the heater when in use. Please use the tabs at the ends of the unit to fold the panel inward.
9. Extreme caution is necessary when any heater is used near a child or the physically disabled.
10. ALWAYS UNPLUG HEATER WHEN NOT IN USE.
11. DO NOT LEAVE THE UNIT UNATTENDED WHEN IN OPERATION.
12. The unit must have a clearance of 71" from the bottom of the unit to the floor and 12" from the top of the unit to the umbrella.
13. This heater is hot when in use. To avoid burns, do not let bare skin touch hot surfaces. If provided, use handles when moving this heater. Keep combustible materials, such as furniture, pillows, bedding, papers, clothes and curtains at least 3 feet from the front of this heater.
14. DO NOT cover the unit with any type of cloth while in operation or a short time after turning the unit off.
15. DO NOT wrap the power cord around the unit.
16. Do not insert or allow foreign objects to enter any ventilation or exhaust opening as this may cause electric shock, fire or damage to the heater.
17. PLEASE HANDLE THE UNIT WITH CARE.
18. DO NOT operate any unit with a damaged power cord or plug or after the heater malfunctions or if it has been dropped or damaged in any manner.
19. DO NOT USE THE UNIT AS A ROOM HEATER.
20. Do not run power cord under carpet; do not cover cord with throw rugs, runners or the like. Arrange cord away from traffic area where it may be tipped over.
21. To disconnect heater, turn controls to off, then remove plug from outlet.
22. To prevent possible fire, do not block air intakes or exhaust openings in any manner. Do not use on soft surfaces, like a bed, where openings may become blocked.
23. Use this heater only as described in this manual. Any other use not recommended by the manufacturer may cause fire, electric shock or injury to persons and property.
24. The heater is not intended for use with an extension cord. Plug the cord directly into an appropriate wall receptacle. If an extension cord is used, it must be a minimum 14AWG and rated not less than 1875 watts.
25. The output of this heater may vary and its temperature may become intense enough to burn exposed skin. Use of this heater is not recommended for persons with sensitivity to heat or an inability to react to avoid burns.

SAVE THESE INSTRUCTIONS

CLEANING AND STORAGE

1. Turn the unit OFF and unplug the unit before cleaning.
2. Use only a soft cloth to clean the exterior.
3. Cleaner can be used to clean the interior.
4. Do not immerse the unit in water and never allow water to drip into the motor housing.

Caution: Do not allow water to run into the interior or the heater as this could create a fire or electric shock hazard.

5. Do not use gasoline, paint thinner or other chemicals to clean the fan
6. Store the fan in its original box and store in a cool, dry place.

NOTE: If you experience a problem, please call customer service 866-985-7877 or see your warranty. Do not attempt to open the motor housing yourself. Doing so may void your warranty and cause damage to the fan or personal injury.

SPECIFICATIONS

Power Supply: 120V / 50Hz

Wattage: 500W on LOW, 1000W on MEDIUM, 1500W MAXIMUM

Net Weight: 3.60 kgs

Gross Weight (with carton):5.0 kgs

GROUNDING INSTRUCTIONS

This product must be grounded, If it should malfunction or breakdown, grounding provides a path of least resistance for electric current to reduce the risk of electric shock This product is equipped with a cord having an equipment – grounding conductor and a grounding plug. The plug must be plugged into an appropriate outlet that is properly installed and grounded in accordance with all local codes and ordinances.

DANGER

Improper connection of the equipment-grounding conductor can result in a risk of electrocution. Check with a qualified electrician or service personnel if you are in doubt as to whether the outlet is properly grounded. Do not modify the plug provided with the product. If it does not fit the outlet, have a proper outlet installed by a qualified electrician. Do not use any type of adaptor with this product.

GROUND FAULT CIRCUIT INTERRUPTER (GFCI) PROTECTION

This unit is provided with a ground fault circuit interrupter (GFCI) built into the plug of the power supply cord, This device provides additional protection from the risk of electric shock. **SHOULD REPLACEMENT OF THE PLUG OR CORD BECOME NECESSARY, USE ONLY IDENTICAL REPLACEMENT PARTS THAT INCLUDE ARCI PROTECTION.**

Distributed By:

Well Traveled Living
716 S 8th Street
Amelia Island, FL 32034
Toll Free: 866-WTL-SUPP
(866-985-7877)

Web: www.wtliving.com
Email: cservice@welltraveled.net



1 YEAR LIMITED WARRANTY – Customers in the Continental US

All components are warranted for a period of 1 year after date of purchase by the original owner against defects in materials and workmanship under normal use. This warranty does NOT cover normal wear and weathering, assembly and/or maintenance OR use in a commercial application. At Well Traveled Living's sole discretion, products under warranty will be repaired and/or replaced at no charge to the customer. Any returns sent back to Well Traveled Living must be sent via prepaid freight and in the original retail packaging.

For warranty service contact Well Traveled Living at the address, phone numbers or internet site and email listed in this owner's manual. Be sure to have your sales receipt, date of purchase and catalogue/model numbers available when calling. All warranty service will be coordinated by the Well Traveled Living's, Amelia Island, Florida service center.

This warranty is extended only to the original purchaser. Proof of purchase will be required before warranty service is rendered. The sales receipt is the only valid proof of purchase. This warranty only covers failures due to defects in materials or workmanship which occur during normal use. Failures and/or damage which result from accident, negligence, misuse, abuse, neglect, mishandling, alteration or modification, failure to maintain, improper assembly or maintenance, service by unauthorized agency or use of unauthorized components or damage that is attributable to acts of God are NOT covered.

*****THERE ARE NO EXPRESS WARRANTIES EXCEPT AS LISTED ABOVE*****

*****PURCHASER ASSUMES ALL RISKS IN THE ASSEMBLY AND OPERATION OF THIS UNIT*****

*****FAILURE TO FOLLOW WARNINGS AND OPERATIONAL INSTRUCTIONS CONTAINED IN THIS MANUAL CAN RESULT IN SEVERE PROPERTY DAMAGE AND/OR PERSONAL INJURY*****

IN NO EVENT WILL WELL TRAVELED LIVING, OR ITS DIRECTORS, OFFICERS OR AGENTS BE LIABLE TO THE PURCHASER OR ANY THIRD PARTY, WHETHER IN CONTRACT, IN TORT, OR ON ANY OTHER BASIS, FOR ANY INDIRECT, SPECIAL, PUNITIVE, EXEMPLARY, CONSEQUENTIAL, OR INCIDENTAL LOSS, COST, OR DAMAGE ARISING OUT OF OR IN CONNECTION WITH THE SALE, MAINTENANCE, USE, OR INABILITY TO USE THE PRODUCT, EVEN IF WELL TRAVELED LIVING OR ITS DIRECTORS, OFFICERS OR AGENTS HAVE BEEN ADVISED OF THE POSSIBILITY OF SUCH LOSSES, COSTS OR DAMAGES, OR IF SUCH LOSSES, COSTS, OR DAMAGES ARE FORESEEABLE. IN NO EVENT WILL WELL TRAVELED LIVING, OR ITS OFFICERS, DIRECTORS, OR AGENTS BE LIABLE FOR ANY DIRECT LOSSES, COSTS OR DAMAGES THAT EXCEED THE PURCHASE PRICE OF THE PRODUCT.

SOME JURISDICTIONS DO NOT ALLOW THE EXCLUSION OR LIMITATION OF INCIDENTAL OR CONSEQUENTIAL DAMAGES, SO THE ABOVE LIMITATION OR EXCLUSION MAY NOT APPLY TO THE PURCHASER.

This limited warranty gives you specific legal rights and you may also have other rights which vary from jurisdiction to jurisdiction. The provisions of the United Nations Convention on Contracts for the Sales of Goods shall not apply to this limited warranty or the sale of products covered by this limited warranty.

*****IMPORTANT NOTICE*****

-Do **NOT** return to place of purchase-

For customer service and warranty issues
contact our Customer Service Center at:

(866)-985-7877 OR

Email: cservice@welltraveled.net

Customer Service Hours: Mon. – Fri. 9:00 a.m. – 6:00 p.m. (EST)

Fire Sense® and Well Traveled Living® are registered trademarks of Well Traveled Imports, Inc®. All assembly instruction presentations are the property of Well Traveled Imports, Inc.® and are protected by U.S. copyrights and trademarks. All rights reserved.