

grilltech

by



Space 800

Instructions for use, maintenance
and assembly



Item # 60531

Assembly

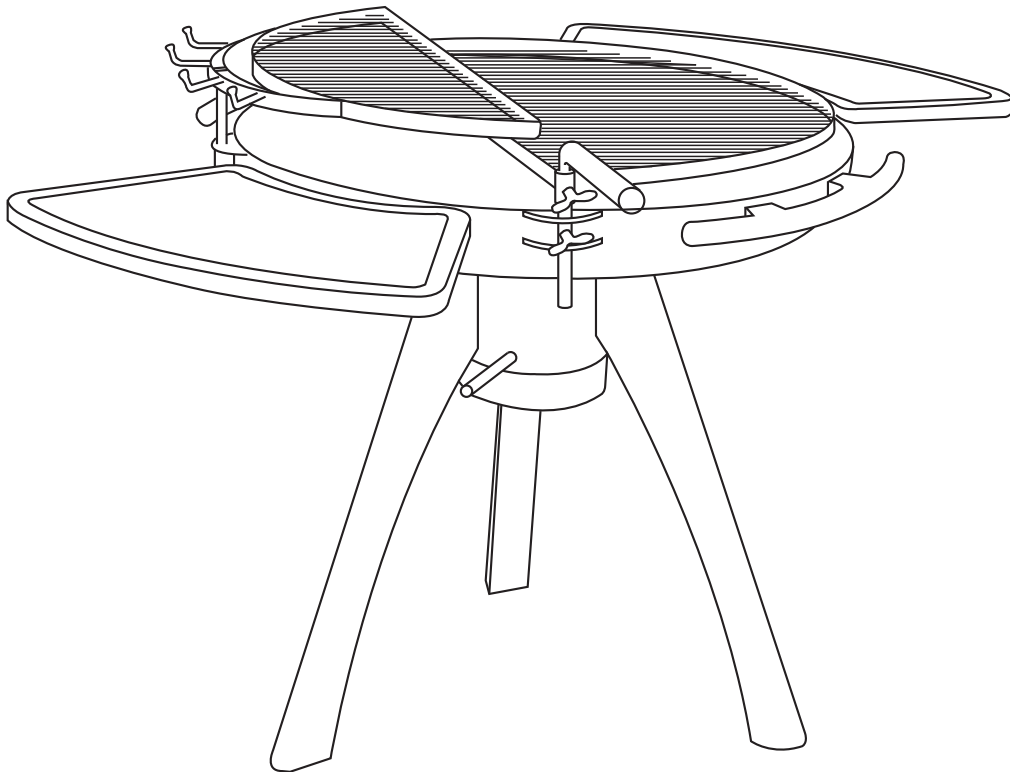
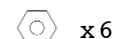
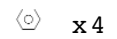
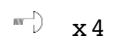
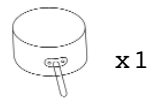
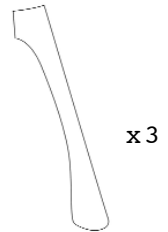
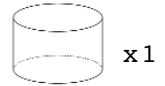
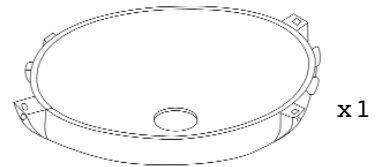
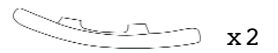
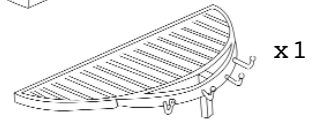
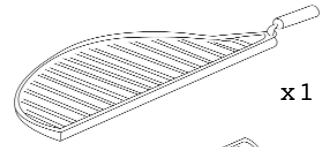
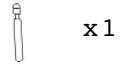
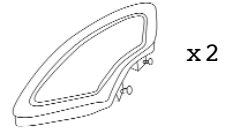
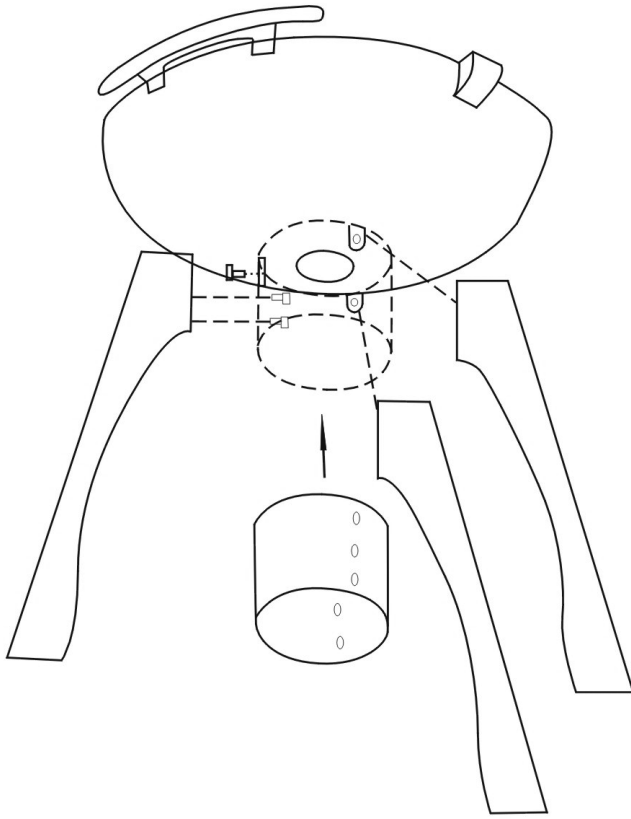

Assembly

READ THE INSTRUCTIONS BEFORE USE.

Distributed by:

Well Traveled Living

P.O. Box 4

Amelia Island, FL32035

Tel: 866-985-7877

Fax: 904-261-6769

1 INTRODUCTION

- Use only in a well ventilated area.
- This appliance must only be used outdoors.
- Do not use under canopies or awnings.
- Do not move the appliance while it is lit.
- For spare parts and servicing contact 866-985-7877 or cservice@welltraveled.net.

The Chopping board must be stored inside!

Safety instructions

FOR YOUR SAFETY:

- 1 Read the assembly instructions carefully. See exploded view and part list.
- 2 Place the fire pit on a hard and flat surface prior to use.
- 3 Do not use indoors or under a shelter.
- 4 Do not use the fire pit close to flammable materials.
- 5 CAUTION! Do not use alcohol, gasoline or comparable fluids for lighting or re-lighting! Only use fire lighters available in stores.
- 6 Fire lighters must be completely consumed before placing food to be grilled. Keep the fire lighters away from children.
- 7 ATTENTION! This fire pit will become very hot. Do not move it during operation.
- 8 WARNING! Keep children and pets away.
- 9 Do not overfill the bowl of your fire pit. It should only be filled to a maximum of 70% of its capacity with charcoal or charcoal briquettes.
- 10 Before the first use with food, let the charcoal burn for 30 minutes in the fire pit and let it cool down.
- 11 How to light the fire pit:

Place the fire lighter in the middle of the bowl and add charcoal on top of the fire lighter in a pyramid shape. Ignite the fire lighter with a stick lighter.
- 12 After lighting, charcoal should burn completely for 30 minutes and until a thin layer of ash is formed on top of the charcoal before placing the food on the grid. Do not cook before the charcoal has a coating of ash.
- 13 After grilling the food, wait until the glow is completely extinct and all charcoal has burned and is no longer hot.
- 14 After use of the fire pit, clean the fire pit and all tools.
 - * ATTENTION! This fire pit will become very hot. Do not move it during operation.
 - * Do not use indoors!
 - * CAUTION! Do not use alcohol, gasoline or comparable fluids for lighting or re-lighting!
 - * WARNING! Keep children and pets away.

CAUTION!

- 1 Fire pits release a strong heat and for this reason must be placed on a non-flammable surface.
- 2 Wait until the charcoal is completely put out before moving the fire pit.
- 3 Keep these instructions in a safe place to refer to them whenever needed.

1 Year Limited Warranty - Customers in the Continental US

All components are warranted for a period of 1 year after date of purchase by the original owner against defects in materials and workmanship under normal use. This warranty does NOT cover normal wear and weathering, assembly and/or maintenance OR use in a commercial application. At Well Traveled Living's sole discretion, products under warranty will be repaired and/or replaced at no charge to the customer. Any returns sent back to Well Traveled Living must be sent via prepaid freight and in the original retail packaging.

For warranty service contact Well Traveled Living at the address, phone numbers or internet site and email listed in this owner's manual. Be sure to have your sales receipt, date of purchase and catalogue/model numbers available when calling. All warranty service will be coordinated by the Well Traveled Living's, Amelia Island, Florida service center.

This warranty is extended only to the original purchaser. Proof of purchase will be required before warranty service is rendered. The sales receipt is the only valid proof of purchase. This warranty only covers failures due to defects in materials or workmanship which occur during normal use. Failures and/or damage which result from accident, negligence, misuse, abuse, neglect, mishandling, alteration or modification, failure to maintain, improper assembly or maintenance, service by unauthorized agency or use of unauthorized components or damage that is attributable to acts of God are NOT covered.

- **THERE ARE NO EXPRESS WARRANTIES EXCEPT AS LISTED ABOVE**
- **PURCHASER ASSUMES ALL RISKS IN THE ASSEMBLY AND OPERATION OF THIS UNIT**
- **FAILURE TO FOLLOW WARNINGS AND OPERATIONAL INSTRUCTIONS CONTAINED IN THIS MANUAL CAN RESULT IN SEVERE PROPERTY DAMAGE AND/OR PERSONAL INJURY**

IN NO EVENT WILL WELL TRAVELED LIVING, OR ITS DIRECTORS, OFFICERS OR AGENTS BE LIABLE TO THE PURCHASER OR ANY THIRD PARTY, WHETHER IN CONTRACT, IN TORT, OR ON ANY OTHER BASIS, FOR ANY INDIRECT, SPECIAL, PUNITIVE, EXEMPLARY, CONSEQUENTIAL, OR INCIDENTAL LOSS, COST, OR DAMAGE ARISING OUT OF OR IN CONNECTION WITH THE SALE, MAINTENANCE, USE, OR INABILITY TO USE THE PRODUCT, EVEN IF WELL TRAVELED LIVING OR ITS DIRECTORS, OFFICERS OR AGENTS HAVE BEEN ADVISED OF THE POSSIBILITY OF SUCH LOSSES, COSTS OR DAMAGES, OR IF SUCH LOSSES, COSTS, OR DAMAGES ARE FORESEEABLE. IN NO EVENT WILL WELL TRAVELED LIVING, OR ITS OFFICERS, DIRECTORS, OR AGENTS BE LIABLE FOR ANY DIRECT LOSSES, COSTS OR DAMAGES THAT EXCEED THE PURCHASE PRICE OF THE PRODUCT.

SOME JURISDICTIONS DO NOT ALLOW THE EXCLUSION OR LIMITATION OF INCIDENTAL OR CONSEQUENTIAL DAMAGES, SO THE ABOVE LIMITATION OR EXCLUSION MAY NOT APPLY TO THE PURCHASER.

This limited warranty gives you specific legal rights and you may also have other rights which vary from jurisdiction to jurisdiction. The provisions of the United Nations Convention on Contracts for the Sales of Goods shall not apply to this limited warranty or the sale of products covered by this limited warranty.

IMPORTANT NOTICE

- **Do NOT return to place of purchase**

For customer service and warranty issues contact our Customer Service Center at: (866)-985-7877 OR
Email: cservice@welltraveled.net

Customer Service Hours: Mon. – Fri. 9:00 a.m. – 6:00 p.m. (EST)

Fire Sense® and Well Traveled Living® are registered trademarks of Well Traveled Imports, Inc®. All assembly instruction presentations are the property of Well Traveled Imports, Inc.® and are protected by U.S. copyrights and trademarks. All rights reserved.



Distributed By:

Well Traveled Living

716 S 8th Street

Amelia Island, FL 32034

Toll Free: 866-WTL-SUPP

Web: www.wtliving.com

Email: cservice@welltraveled.net